



Brewer

**Founded by E.F. Brewer in 1947**, the Brewer Company began as a custom tube fabricator constructing truck and train seat frames and dinette sets. In the 1950's, Brewer expanded its market by introducing some of the first chrome stools made especially for the popular restaurants and diners of the time.

In the 1960's, fueled by the success found in the seating industry, Brewer developed and released a comprehensive line of medical exam seating that was the beginning of the product lines we offer today.

Today, Brewer leads the industry in innovation through our comprehensive line of power procedure and exam tables. Each product design is developed with the needs of physicians, nurses, and patients in mind. All products focus on innovative technology and patented features that increase the safety, efficiency, and comfort in the healthcare environment.

We encourage you to examine our full line of healthcare products and equipment.

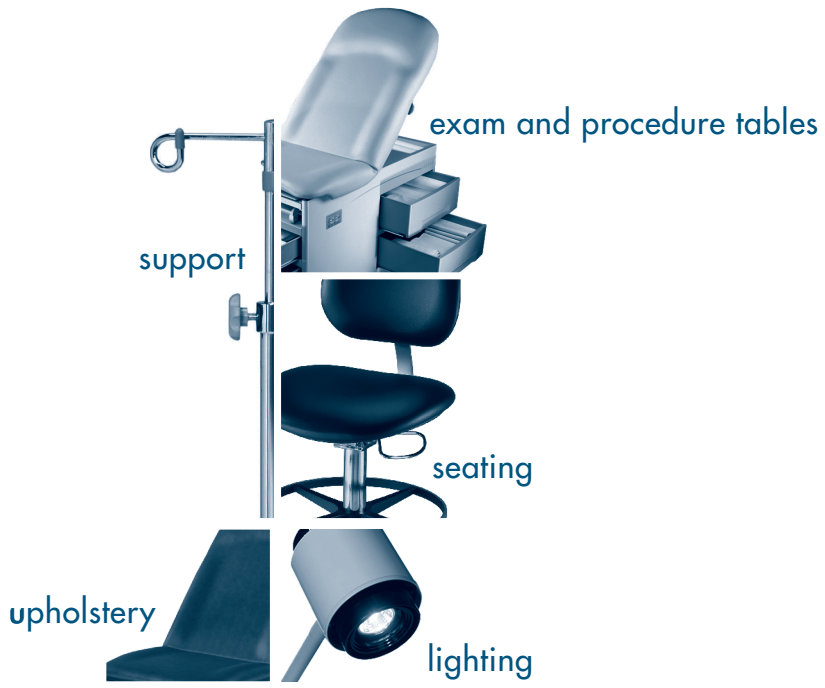

Brewer

# LiftMate™

## Brewer Low/High Patient Lift



- Helps prevent patient falls
- Improves clinical staff safety
- Removes patient mobility barriers
- Reduces capital investment
- Mobile, maneuverable and easy to use

*Lift with your finger, not your back.*



[www.brewerliftmate.com](http://www.brewerliftmate.com)

models

#3000 Brewer LiftMate™ Low/High Mobile Patient Lift

### Safety

- Standard three-year warranty
- 500 lb (226 kg) weight capacity
- Large non-slip platform surface
- Two emergency stop buttons
- Grab bars for patient stability and positioning
- Four auto-lock rubber feet for stability
- Four retractable swivel casters prevent rolling during use

### Function

- Convenient hand pendant for easy operation
- Powered by standard outlet plug or rechargeable battery
- Easy-to-clean design
- Fits through standard doorways

### Patient Safety

- Smooth movement for enhanced patient security
- Quiet actuators for patient comfort
- Large platform with ample room for patient positioning
- Easy access for walkers
- Designed to prevent patient falls
- Raises from 1" to 10", two inches taller than average table step

### Caregiver Benefits

- Easy-to-use mobile device
- Reduces need to assist patients onto exam tables
- Protects employees from workplace hazards

### Dimensions

- Height: 38" - 47" (96.5 cm-119.4 cm)
- Depth (outer dimensions): 21.5" (54.6 cm)
- Width (outer dimensions): 34.75" (88.3 cm)
- Depth (platform): 18" (45.7 cm)
- Width (platform): 21.5" (54.6 cm)
- Width (between grab bars): 27.75" (70.5 cm)

### Electrical

- 115 VAC, 60 Hz
- Current in: 2.0 amp max
- Class II double insulated
- Safe, extra-low voltage actuators

### Battery

- Lead Acid Sealed Battery
- Rechargeable, 24 volt, 1.2 amp-hour capacity
- Light/Audible signal to indicate low battery charge
- Replacement Part No.: 2102150

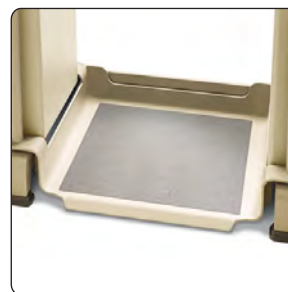

# BrewerAssistPRO

POWER PROCEDURE TABLE

## BrewerAssist

POWER PROCEDURE TABLE



#7000 in Blue Fog

### models

#7000 Assist Power Procedure Table

#7500 AssistPRO Programmable Power Procedure Table

### accessories

#99497 grab bars (pair)\*\*

#99499 articulating armboard\*\*

#99500 hand pendant kit for Assist 7000

#99501 side seat rails (pair of 2)

#99502 one universal socket clamp

#99504 deluxe articulating knee crutches (left & right)\*

#99505 stainless steel treatment pan

#100253 urology drain pan system

#101726 hand pendent replacement kit for AssistPRO 7500

#102024 Brewer Welch Allyn® Exam Light IV bracket - plant installed

#102025 Brewer Welch Allyn® Exam Light IV bracket - field installed

\* needs one order of #99501 and two orders of #99502

\*\* needs one order of #99501

### AssistPRO Programmability

- Intuitive hand pendant and foot control included
- Four preferred positions can be programmed into memory
- Simple two-step programming process
- Visual and audible signals create a user-friendly interface
- Auto-run toggle for safety

### Advanced Safety

- Safety release actuators
- Safe extra-low voltage actuators
- 19" (48.3 cm) low height
- 40" (101.6 cm) maximum height
- Leg rest extends an additional 5" (12.7 cm)
- Adjustable three-point pivot headrest
- Easy-to-clean seamless upholstery
- 18" (45.7 cm) or 21" (53.3 cm) paper dispenser

### Patient Comfort

- Easy lateral wheelchair transfers
- Infinitely adjustable headrest
- Extendable leg rest
- Multi-density, bolstered support upholstery

### Table Specifications

- 450 lb (204 kg) weight capacity
- Standard three-year warranty
- Standard adjustable stirrups
- Standard foot control
- Hand pendant standard on AssistPRO (7500 models)
- Height: 19" – 40" (48.3 cm – 101.6 cm)
- Length: 69" (75.3 cm)
- Length with headrest & leg rest extended: 80" (203.2 cm)
- Length in upright position: 40" (101.6 cm)
- Width: 28" (71.1 cm)
- Leg rest: 16.6" x 11.25" (42.2 cm x 27.9 cm)
- Headrest: 13" x 11" (33 cm x 27.9 cm)
- Tilt range / Trendelenburg: to 30°
- Base: 24" W x 36" L (61 cm x 91.4 cm)
- Power cord: 70" (177.8 cm)
- 115 VAC, 60 Hz
- 15 standard upholstery color options
- CAL-133 fire resistant upholstery available in 4 colors
- Premium, plush upholstery available in 5 colors
- Custom colors available

Brewer AssistPRO Power Procedure Table offers four pre-programmed positions. Brewer's Power Procedure Tables are infinitely adjustable to meet any procedure needs.



Supine



Left Lateral Plane



Lithotomy



Proctology

# BrewerAccess High-Low EXAM TABLE 700



#6801 in  
Plush Admiral

## models

#6800	Access High-Low 700 with power back
#6801	Access High-Low 700 with power back, pelvic tilt, front drawer heater and outlet

## accessories

#98464	stainless steel treatment pan
#99502	one universal socket clamp
#99504	deluxe articulating knee crutches*
#100253	urology drain pan system
#100407	front drawer dividers
#100540	two support adapters for knee crutches - plant installed
#100550	two support adapters for knee crutches - field installed
#102031	Brewer Welch Allyn® Exam Light IV bracket - plant installed
#102032	Brewer Welch Allyn® Exam Light IV bracket - field installed

\*needs two orders of #99502 and one order of either #100540 or #100550

### Advanced Safety

- Safety grab bars for patient stability and positioning
- Return-to-chair feature
- Anti-tamper on/off switch prevents accidental movement
- Sensors prevent injuries during table movement
- 18" low height, 28" when flat (45.7 cm, 71.1 cm)
- Easy on/off for patients
- Powered backrest adjusts for easy patient positioning

### Patient Comfort

- Easy lateral wheelchair transfers
- Multi-density support upholstery
- Standard adjustable ergonomic stirrups
- Toe board/leg extension/stainless steel debris tray

### Abundant Storage

- Pass-through work surface on side of table
- Patented pass-through side drawers accessible from right or left side of the table
- Front drawer: 19.8" x 19.2" x 3.8" (50.5 cm x 48.9 cm x 9.8 cm)
- Side drawers: 22.6" x 20.2" x 7" (57.5 cm x 51.4 cm x 17.8 cm)
- Covered storage for up to 6 additional paper rolls
- Paper storage capacity: 23"x 23"x 3.25" (58 cm x 58 cm x 8 cm)
- Slide through holder accepts 21" & 18" rolls (53.3 cm & 45.7 cm)

### Table Specifications

- 700 lb (317 kg) weight capacity
- Standard patient assist grab bars
- Standard adjustable stirrups
- Standard foot control
- Standard three-year warranty
- Height: 18" - 37" (45.7 cm - 94 cm)
- Length: 57" extends to 78" (144.8 cm - 198.1 cm)
- Upholstery width: 28" (71.1 cm)
- Leg extension length: 21" (53.3 cm)
- Goes flat at 28" (71.1 cm)
- Standard Outlet: 115VAC, 60 Hz, 5.8 amps max
- Safe, low voltage actuators
- Safe, single power cord design, detachable
- Easy to clean, seamless upholstery
- 15 standard upholstery color options
- CAL-133 fire resistant upholstery available in 4 colors
- Premium, plush upholstery available in 5 colors
- Custom colors available

### 6801 model only:

- Hospital grade outlet standard
- 115VAC, 60 Hz, 9.3 amps max
- 5° pelvic tilt, 60-Watt drawer heater in front top drawer



# BrewerAccess High-Low EXAM TABLE



#6500 in  
Blue Fog

## models

- #6000 Access High-Low with pneumatic back
- #6001 Access High-Low with pneumatic back, pelvic tilt, and front drawer heater
- #6500 Access High-Low with power back
- #6501 Access High-Low with power back, pelvic tilt, front drawer heater and outlet

## accessories

- #98464 stainless steel treatment pan
- #99502 one universal socket clamp
- #99504 deluxe articulating knee crutches\*
- #100253 urology drain pan system
- #100407 front drawer dividers
- #100540 two support adapters for knee crutches - plant installed
- #100550 two support adapters for knee crutches - field installed
- #101800 electrical outlet (6001 only - plant install - must order w/table)
- #102031 Brewer Welch Allyn® Exam Light IV bracket - plant installed
- #102032 Brewer Welch Allyn® Exam Light IV bracket - field installed

\*needs two orders of #99502 and one order of either #100540 or #100550

### Advanced Safety

- Safety grab bars for patient stability and positioning
- Return-to-chair feature on power back models
- Anti-tamper on/off switch prevents accidental movement
- Sensors prevent injuries during table movement
- 18" low height, 28" when flat (45.7 cm, 71.1 cm)
- Easy on/off for patients
- Backrest adjusts for easy patient positioning (pneumatic or power back available)

### Patient Comfort

- Easy lateral wheelchair transfers
- Multi-density support upholstery
- Standard adjustable ergonomic stirrups
- Toe board/leg extension/stainless steel debris tray

### Abundant Storage

- Pass-through work surface on side of table
- Patented pass-through side drawers accessible from right or left side of the table
- Front drawer: 19.8" x 19.2" x 3.8" (50.5cm x 48.9cm x 9.8cm)
- Side drawers: 22.6" x 20.2" x 7" (57.5cm x 51.4cm x 17.8cm)
- Covered storage for up to 6 additional paper rolls
- Paper storage capacity: 23"x 23"x 3.25" (58 cm x 58 cm x 8 cm)
- Slide through holder accepts 21" & 18"rolls (53.3 cm & 5.7 cm)

### Table Specifications

- 450 lb (204 kg) weight capacity
- Standard patient assist grab bars
- Standard adjustable stirrups
- Standard foot control
- Standard three-year warranty
- Height: 18" - 37" (45.7 cm - 94.1 cm)
- Length: 57" extends to 78" (144.8 cm - 198.1 cm)
- Upholstery width: 28" (71.1 cm)
- Leg extension length: 21" (53.3 cm)
- Goes flat at 28" (71.1 cm)
- Optional Outlet: 115VAC, 60 Hz, 5.8 amps max, plant install only, must be ordered with table, orientation is on patient's left
- Safe, low voltage actuators
- Safe, single power cord design, detachable
- Optional 5° pelvic tilt, 60-Watt drawer heater in front top drawer
- Easy to clean, seamless upholstery
- 15 standard upholstery color options
- CAL-133 fire resistant upholstery available in 4 colors
- Premium, plush upholstery available in 5 colors
- Custom colors available



Chair



Table

# BrewerAccess

## EXAM TABLE



### models

- #5000 Access Exam Table
- #5001 Access Exam Table with pelvic tilt, front drawer heater and outlet

### accessories

- #98464 stainless steel treatment pan
- #100253 urology drain pan system
- #100407 front drawer dividers
- #102022 Brewer Welch Allyn® Exam Light IV bracket - plant installed
- #102023 Brewer Welch Allyn® Exam Light IV bracket - field installed

### Advanced Safety

- Stable four-leg patient step
- Largest step surface area available
- Simple pneumatic backrest for easy patient positioning

### Patient Comfort

- Adjustable ergonomic stirrups
- Leg extension / plastic debris tray
- Multi-density support upholstery

### Abundant Storage

- Largest storage capacity available
- Patented pass-through side drawers accessible from right or left side
- Front drawer: 19.8" x 19.2" x 3.8" (50.5 cm x 48.9 cm x 9.8 cm)
- Side drawers: 22.6" x 20.2" x 7" (57.5 cm x 51.4 cm x 17.8 cm)
- Slide through holder accepts 21" & 18" rolls (53.3 cm & 45.7 cm)
- Additional paper storage under backrest

### Table Specifications

- 500 lb (226 kg) weight capacity
- Standard five-year warranty
- Standard adjustable stirrups
- Height: 32" (81.3 cm)
- Length: 57.3" (145.5 cm) extends to 71" (180.3 cm)
- Width: 28" (71.1 cm)
- Leg extension length: 15" (38.1 cm)
- Step Dimensions: 20.4"W x 17.7"L x 8"H (51.8cm x 45 cm x 20.3cm)
- Standard Outlet: 115VAC, 60Hz, 5.8 amps max, hospital grade duplex, easily positioned to left or right side from patient's perspective
- Easy-to-clean seamless upholstery
- 15 standard upholstery color options
- CAL-133 fire resistant upholstery available in 4 colors
- Custom colors available

### Options

- 5° pelvic tilt, 60-Watt drawer heater in front top drawer



### Table Specifications

- 500 lb (226 kg) weight capacity
- Standard three-year warranty
- All steel frame construction
- Two-piece top design allows single person delivery, freight savings
- Adjustable back models have six positions
- Optional drawer models can be made left or right handed with space for six paper rolls
- Paper holder accepts 21" & 18" paper rolls (53.3 cm & 45.7 cm rolls)
- Easy-to-clean seamless upholstery
- 15 standard upholstery color options
- CAL-133 fire resistant upholstery available in 4 colors
- Custom colors available
- Some easy assembly is required

### Table Dimensions with Upholstery

- Height: 31" (78.7 cm)
- Length: 74" (188 cm)
- Width: 28" (71.1 cm)

### Optional Drawer Dimensions

- Length: 19" (48.3 cm)
- Width: 20" (50.8 cm)

### Optional Shelf Dimensions

- Length: 65.75" (167 cm)
- Width: 18" (45.7 cm)



# BrewerBasic

## EXAM TABLE



#4000 in Cabernet

### models

- #4000 Basic Exam Table
- #4001 Basic Exam Table with drawer heater and pelvic tilt

### accessories

- #98464 stainless steel treatment pan
- #100253 urology drain pan system
- #100407 front drawer dividers
- #102022 Brewer Welch Allyn® Exam Light IV bracket - plant installed
- #102023 Brewer Welch Allyn® Exam Light IV bracket - field installed

### Advanced Safety

- Sturdy, retractable patient step with mat
- Simple pneumatic back for easy patient positioning

### Patient Comfort

- Adjustable ergonomic stirrups
- Leg extension / plastic debris tray
- Multi-density support upholstery

### Abundant Storage

- Largest storage capacity available
- Side drawers available on right or left side (from patients perspective)
- Front drawer: 19.8" x 19.2" x 3.8" (50.5 cm x 48.9 cm x 9.8 cm)
- Side drawers: 22.6" x 20.2" x 7" (57.5 cm x 51.4 cm x 17.8 cm)

### Table Specifications

- 325 lb (147 kg) weight capacity
- Standard three-year warranty
- Height: 32" (81.3 cm)
- Length: 57.5" (146.1 cm) extends to 71" (180.3 cm)
- Width: 26.5" (67.3 cm)
- Leg extension length: 15" (38.1 cm)
- Step Dimensions: 20.5"W x 11"L x 8.6"H (52.1 cm x 27.9 cm x 21.8 cm)
- Easy-to-clean seamless upholstery
- 15 standard upholstery color options
- CAL-133 fire resistant upholstery available in 4 colors
- Custom colors available







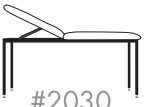

### Options

- 5° pelvic tilt, 60-Watt drawer heater in front top drawer

# BrewerElement

## TREATMENT TABLE

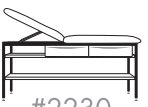
### MODELS

	flat top	flat top adjustable	pillowtop adjustable
basic frame	 #2010	 #2030	 #2040
frame w/shelf	 #2110	 #2130	 #2140
frame w/shelf & drawers	 #2210	 #2230	 #2240

### accessories

- #10196 table paper strap (Qty 2)
- #100407 drawer separators (Drawer models only)

# MILLENNIUM SERIES

Premium specialty seating with ergonomic design.

## Millennium Series Stool Specifications

- 18.5" (47 cm) wide contoured seat cushion
- Adjustable contoured backrest with black plastic shroud, excl. #21340 & #21340V
- 2" (5.1 cm) dual-wheel nylon casters with polyurethane tread; locking caster optional
- 23" (58.4 cm) five leg powder coated black aluminum base
- Ergonomic design; seamless upholstery standard, excl. #21340
- 47 standard upholstery color options
- Weight capacity: 250 lb (113 kg)
- Standard five-year warranty

accessories for millennium series:

#2102265 Set of 5 pressurized locking casters

B - backrest  
V - seamless/vacuum formed  
A - arm rests



21435BA in Azure Blue

21521B in Adriatic

21340B in Blue Fog

## TASK

- Pneumatic height adjustment: 18" - 24.75" (48.7 cm - 62.9 cm)
- Fully adjustable forward seat tilt
- Adjustable backrest with synchronized traversing movement of seat



#21435BA  
w/ arm rests

#21435B  
w/o arm rests

## LAB

- Pneumatic height adjustment:  
Glides: 20.75" - 31" (52.7 cm - 78.7 cm)  
Casters: 21.75" - 32" (55.2 cm - 81.3 cm)
- 18" (48.7 cm) foot ring standard



#21520B w/glides  
#21521B w/casters

## SURGEON

- Hands-free foot pneumatic height adjustment: 19" - 24" (48.3 cm - 61 cm)
- 18.5" (47 cm) poly-foam seat cushion on 21340B only; 16" (40.6 cm) wide on 21340
- Seamless upholstery not standard on 21340



#21340B  
#21340BV

#21340  
#21340V

# CENTURY SERIES

Preferred by medical facilities worldwide.

## Century Series Stool Specifications

- 16" (40.6 cm) wide, 4" (10.2 cm) thick poly-foam seat cushion
- Pneumatic height adjustment; two heights available: 17.75" - 24.5" (45.1 cm - 62.2 cm); 20" - 27.5" (50.8 cm - 69.9 cm)
- Five-leg, 23" (58.4 cm) brushed aluminum accent base
- Chrome hooded, dual wheel casters; locking casters (LCD) and glides (G) available
- Optional adjustable contoured backrest with black plastic shroud
- Adjustable 18" (48.7 cm) foot ring standard on higher height models
- 47 standard upholstery color options
- CAL-133 fire resistant upholstery available in 4 colors (-C133)
- Premium, plush upholstery available in 5 colors (-UL)
- Weight capacity: 250 lb (113 kg)
- Standard five-year warranty



#11001BFR  
in Cabernet

# VALUE PLUS SERIES

Affordable without compromising style and reliability.



#22500B  
in Cocoa

### Value Plus Series Stool Specifications

- 15" (38.1 cm) wide, 4" (10.2 cm) thick poly-foam seat cushion
- Pneumatic or spinlift height adjustment
- Five-leg, 21" (53.3 cm) black ABS plastic composite base
- 2" (5.1 cm) black plastic dual-wheel nylon casters
- Optional adjustable contoured backrest with black plastic shroud
- 47 standard upholstery color options
- CAL-133 fire resistant upholstery 4 colors, for 22500 models

B - backrest  
V - seamless/vacuum formed  
C133 - Cal 133 upholstery

height range

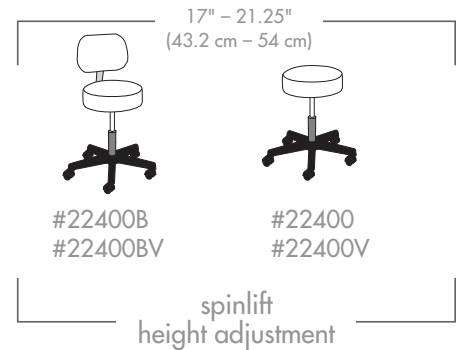
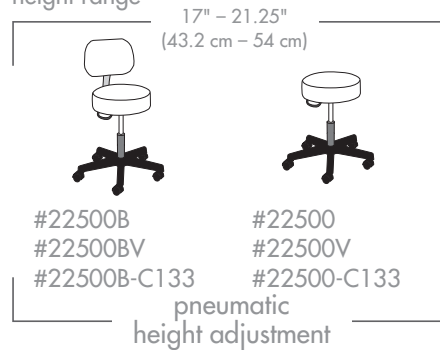

#23051  
in Adriatic

Economical exam stools that stand the test of time.

# TRADITION SERIES

### Tradition Series Stool Specifications

- 14" (38.1 cm) wide, 3.5" (10.2 cm) thick poly-foam seat cushion
- Spinlift height adjustment
- Sturdy four-leg, 19.5" (49.5 cm) chrome base
- 2" (5.1 cm) rubber wheel, ball bearing casters
- 47 standard upholstery color options
- Standard five-year warranty

height range

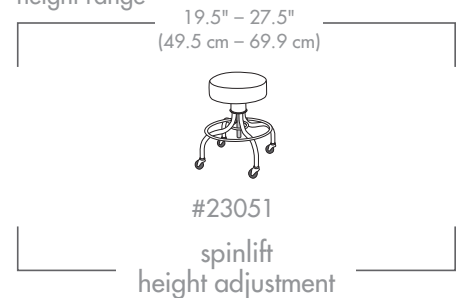

height range

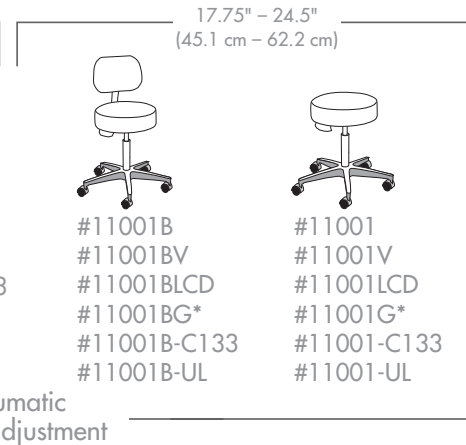
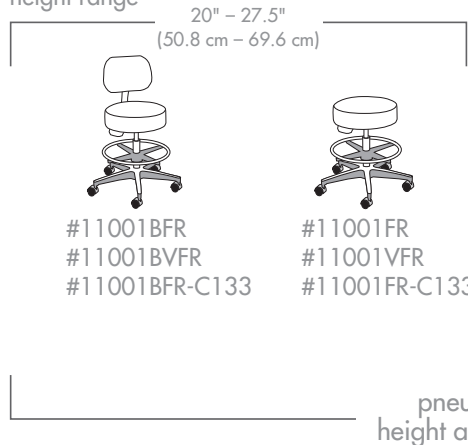

B - backrest  
V - seamless/vacuum formed  
LCD - locking casters  
G - glides  
FR - footing  
C133 - CAL-133 upholstery  
UL - Ultraleather™ upholstery

\*Height range: 16.75" - 23.5"  
(42.5 cm - 59.7 cm)

**All Seating • 5 Year Warranty**

# SIDE CHAIRS

## SERIES

Comfort. Reliability. Durability

### Chair Specifications

- Perfect for the exam room, front office or waiting room environment
- Kick-out leg design helps prevent wall dings and dents
- Comfortable, 2" (5.1 cm) thick poly-foam seat cushion
- Seat 18" x 18" (45.7 cm x 45.7 cm)
- Contoured backrest 18" x 13.38" (45.7 cm x 34 cm)
- Premium, plush upholstery available in 5 colors
- Black plastic backrest shroud for easy cleaning
- Durable steel tube frame
- Weight capacity: 250 lb (113 kg)
- Standard five-year warranty
- 15 standard upholstery color options
- Meets BIFMA (Business and Institutional Furniture Manufacturer's Association) Standards

### Model with arms:

- Sturdy plastic arm rests
- Inside arm width: 20" (50.8 cm)
- Outside arm width: 23" (58.4 cm)



# BLOOD DRAWING CHAIR

## SERIES

Comfort. Adjustability. Durability.

### Patient Comfort

- 2" (5.1 cm) thick poly-foam seat cushion
- Seat alignment positions patients securely on chair
- Innovative angled armrests allow optimal arm position for blood drawing
- Contoured, seamless upholstery for easy cleaning
- 15 standard upholstery color options
- Custom colors available

### Chair Specifications

- Weight capacity: 350 lb (158 kg) weight capacity
- Standard five-year warranty
- Durable, powder-coated welded steel tube frame
- Two standard add-on work surfaces to accommodate prep materials, paperwork, and vials; 8" L x 12" W (20.3 cm x 30.5 cm)
- Work surfaces are easily removable to accommodate space constraints
- Taper-lock armrest knob adjustment system ensures smooth movement
- Optional drawer attaches on either side of chair; #101059
- Work surfaces covered in a bacteriological, chemical, and fungal resistant material
- Meets BIFMA (Business and Institutional Furniture Manufacturer's Association) standards

### Chair Dimensions

- Height: 37" (94 cm)
- Length: 23.5" (59.7 cm)
- Width: 20" (50.8 cm), 29.25" (74.3 cm) with armrests, 43.25" (109.9 cm) with both work surfaces
- Floor to top of seat: 22" (55.9 cm)
- Chair depth: 23.5" (59.7 cm)
- Armrest Angle: 15°
- Armrest Height: 29.5" - 38" (74.9 cm - 96.5 cm)
- Seat cushion: 18" x 18" (45.7 cm x 45.7 cm)
- Backrest cushion: 18" x 12.5" (45.7 cm x 31.8 cm)



### OPTIONAL BLOOD DRAWING CHAIR DRAWER

#### Drawer Specifications

- Easily attaches to either side of chair
- Work surfaces covered in a bacteriological, chemical, and fungal resistant material
- Interior plastic lining for easy cleaning

#### Drawer Dimensions

- Height: 4" (10.2 cm)
- Width: 7" (17.8 cm)
- Length: 10" (25.4 cm)

#101059



All Seating • 5 Year Warranty

# LED ECO-SERIES

## Light

- Bright, best-in-class white light drives clinical efficiency
- Cool to the touch and easy to maneuver
- 6" long, 5" dia., tri-lobed face
- Maximum 170° left/right head rotation
- 12-Watt LED bulb included
- Color temperature - 4000° Kelvin
- 8800 Lumens; 5" Beam Dia. at 18"
- Bulb life: 50,000 hrs

## Arm

- Flexible, "no-drift," 23" (50.4 cm) gooseneck
- Maximum Height: 66" (167.6 cm)
- Smooth, easy-to-clean

## Base

- Internal power cord exits the weighted base at floor level
- Optional five-caster base
- Base Diameter: 13" (33 cm)
- Cord length: 10' (304.8 cm)

#19100 beige

## accessories

#200165 five-caster base - beige



# HALOGEN 35 SERIES

## Light

- Crisp white light
- Non-metallic head eliminates surface heat
- Dichroic film-coated reflectors filter out 80% of beam heat
- Heat sink technology removes bulb socket heat and keeps the housing cool
- High intensity, low voltage 35-Watt bulb included
- Color temperature - 3000° Kelvin
- 1500 Footcandles @ 24" (61 cm)
- Bulb life: 4000 hrs

## Arm

- Flexible, "no-drift," 24" (61 cm) gooseneck
- 540° rotation of light head and gooseneck arm
- Maximum Height: 65.5" (166.4 cm)

## Base

- Internal power cord exits the weighted base at floor level
- Optional five-caster base (shown)
- Base Diameter: 13" (33 cm)
- Cord length: 9' 3" (281.9 cm)

#18100 beige

## accessories

#001635 35-Watt replacement bulb

#200165 five-caster base - beige



# INCANDESCENT SERIES

## Light

- Advanced reflector system provides shadow-free, crisp white light
- Non-metallic head eliminates surface heat
- 25-Watt incandescent bulb included
- Bulb life: 500 hrs

## Base

- Internal power cord exits the weighted base at floor level
- Optional five-caster base
- Base Diameter: 13" (33 cm)
- Cord length: 9' 3" (281.9 cm)

#17100 beige

## accessories

#001525 25-Watt replacement bulb

#200165 five-caster base - beige



## Arm

- Flexible, "no-drift," 18" (45.7 cm) gooseneck offers superior beam alignment
- 540° rotation of light head and gooseneck arm
- Maximum Height: 62" (157.5 cm)

# CHROME SERIES

## Light

- 10 to 40-Watt incandescent bulb (not included)

## Arm

- Durable chrome finish
- 11" (27.9 cm) gooseneck
- Maximum Height: 72" (182.9 cm)
- 360° adjustment

## Base

- Stable chrome plated base
- Base Diameter: 11" (27.9 cm)
- Grounded 3-wire plug
- Cord length: 12' (365.8 cm)

#11500 chrome

*Some assembly is required*

All Brewer products conform to US and Canadian electrical and medical industry codes and regulations and meet or exceed industry requirements.



All Lighting • 1 Year Warranty

# SUPPORT PRODUCTS



## Short Wheel Infusion Pump Stand

- Heavy center weight affords stability while saving space, 16" diameter (40.6 cm)
- Tough five-leg epoxy coated steel base
- Chrome plated top post assembly
- 3" (7.6 cm) rubber wheel, ball bearing casters
- Exclusive "No Loss" knob
- Height: 54" - 90.5" (137.2 cm - 229.9 cm)
- Load capacity: 45 lb (20 kg)

#43416  
2 ram's horn hook

#43417  
4 ram's horn hook



## Large Infusion Pump Stand

- The most stable base available, 26" diameter (66 cm diameter)
- Handles up to four infusion pumps and/or IV controllers (w/43430 and 43433 accessories)
- Tough six-leg epoxy coated steel base
- Chrome plated top post assembly
- 3" (7.6 cm) rubber wheel, ball bearing casters
- Exclusive "No Loss" knob
- Height: 52.25" - 102.75" (132.7 cm - 261 cm)
- Load capacity: 45 lb (20 kg)

#43408  
2 ram's horn hook

#43409  
4 ram's horn hook

## ACCESSORIES FOR 43416, 43417, 43408, 43409

The following accessories all attach with the #43433 clamp, which is sold separately

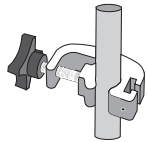

### Universal Clamp

- Fast, flexible attachment & positioning of accessories
- Set-screw locks accessory in place
- Secure grip; versatile adjustment

#43433

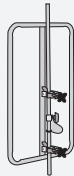

### Infusion Pump Frame

- Mount up to four pumps on a single stand
- Easy mounting, removal & adjustment of pump rack
- Only suitable for use with #43408 and #43409 infusion pump stands

#43430



### Oxygen Cylinder Holder

- Holds "D" and "E" size tanks
- Excellent for ambulatory patients

#43429

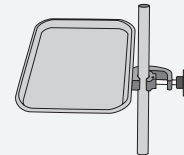

### Add-A-Tray

- Holds instruments or patient items
- Removable stainless steel tray
- Tray size: 9.75" x 13.5" x 0.75" (48.9 cm x 32.1 cm x 1.9 cm)

#43431



## Heavy Base Four-Leg IV Pole

- Tough four-leg epoxy coated 22" (55.9 cm) dia. steel base
- Chrome plated steel tubing
- 3" (7.6 cm) rubber wheel, ball bearing casters
- Exclusive "No Loss" knob
- Rubber bumpers on legs to protect walls
- Height: 51.75" - 93.5" (131.5 cm - 237.5 cm)
- Load capacity: 45 lb (20 kg)
- Some assembly required

#43403  
2 ram's horn hook

#43406  
4 ram's horn hook

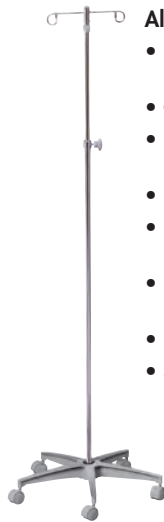

## Aluminum Base Five-Leg IV Pole

- Five-leg, 25" (63.5 cm) dia. cast aluminum base
- Chrome plated steel tubing
- 2" (5.1 cm) dual wheel nylon casters
- Exclusive "No Loss" knob
- Rubber bumpers on legs to protect walls
- Height: 52.25" - 92.75" (132.7 cm - 235.6 cm)
- Load capacity: 45 lb (20 kg)
- Some assembly required

#11350  
2 ram's horn hook

#11360  
4 ram's horn hook



## Two-Hook Four-Leg IV Pole

- Four-leg, epoxy coated 22" (55.9 cm) steel base
- Chrome plated steel tubing
- Dual wheel nylon casters
- Easy twist lock height adjustment
- Height: 47" - 84.5" (119.4 cm - 214.6 cm)
- Load capacity: 45 lb (20 kg)
- Some assembly required

#11300  
2 ram's horn hook



### 18" Round Linen Hamper (45.7 cm)

- Durable chrome plated steel
- Sturdy three-wheel base w/ 2" (5.1 cm) rubber wheel, ball bearing casters
- Dimensions: 35.25" H x 19" outside diameter (89.5 cm x 48.3 cm)
- Some assembly required

#33330

accessories

- |        |   |
|--------|---|
| #31331 | 18" rope style bag, 10 oz. beige cotton |
| #34000 | bag holder                              |



### Tilt-Top Square Hamper

- Open design, easy unloading, minimal lifting
- Step-on pedal for hands-free use
- Steel prop for keeping lid open
- Gray epoxy coated steel lid
- Built-in bag holder supports heavy-duty bags
- Sturdy four-wheel base w/ 3" (7.6 cm) locking rubber wheel, ball bearing casters
- Dimensions: 37" H x 18.5" W x 19.5" D (94 cm x 47 cm x 49.5 cm)
- Some assembly required

#11410

accessories

- |        |   |
|--------|---|
| #31331 | 18" rope style bag, 10 oz. beige cotton |
|--------|---|



### 18" Tilt-Top Round Linen Hamper (45.7 cm)

- Durable chrome plated steel lid and frame
- Step-on pedal for hands-free use
- "M" style base for stability
- Spring loaded lid for easy opening
- Lid remains open while using
- Sturdy four-wheel base w/ 2" (5.1 cm) rubber wheel, ball bearing casters
- Dimensions: 35.75" H x 19" outside diameter (90.8 cm x 48.3 cm)
- Some assembly required

#33334

accessories

- |        |   |
|--------|---|
| #31331 | 18" rope style bag, 10 oz. beige cotton |
| #34000 | bag holder                              |



### Adjustable Folding Linen Hamper

- Adjusts to hold 18", 22", or 25" diameter bags (45.7 cm, 55.9 cm, 63.5 cm)
- Durable chrome plated finish and solid steel bag rest
- Can be folded for compact storage
- Bag rest allows maximum air circulation
- Sturdy four-wheel base w/ 3" (7.6 cm) rubber wheel, ball bearing casters
- Dimensions: 39.5"H x 20"W x 20"D (100.3 cm x 50.8 cm x 50.8 cm)

#33395

accessories

- |        |  |
|--------|--|
| #31331 | 18" rope style bag, 10 oz. beige cotton    |
| #31341 | 22-25" rope style bag, 10 oz. beige cotton |



### Stainless Steel All Purpose Cart

- Non-corrosive stainless steel construction
- 3 stainless steel shelves, 15.5" W x 24" L (39.4 cm x 61 cm)
- Roomy 12" (30.5 cm) between shelves
- Quietly rides on 3.5" (8.9 cm) rubber wheel casters
- Total weight capacity: 300 lb (136 kg)
- Dimensions with handle: 28 L x 15.5" W x 33" H (71.1 cm x 39.4 cm x 83.8 cm)

#63500 assembled



### Plastic Utility Cart

- 3 ABS plastic shelves, 21.75" x 16" (55.3 cm x 40.6 cm)
- 12" (30.5 cm) between shelves
- Four 3" (7.6 cm) non-locking, swivel polyurethane ball-bearing casters
- Total capacity: 200 lb (45 kg)
- Dimensions with handle: 25.25 L x 17.5" W x 35" H (64.8 cm x 44.5 cm x 94 cm)
- Light grey color; Some assembly required

#63530 assembly required



### Multi Purpose Cart

- Strong chrome plated steel frame
- 3" (7.6 cm) rubberwheel, ballbearing casters
- Convenient height of 37.5" (95.3 cm)
- Coated steel basket supports
- Total capacity: 50 lb (22.7 kg)
- No assembly required
- Dimensions: 37.5" H x 19.5" W x 30" D (95.3 cm x 49.5 cm x 76.2 cm)
- Baskets sold separately

- |          |                               |
|----------|-------------------------------|
| #63400   | cart frame only               |
| #63021   | 12" wire basket               |
| #63020-1 | 6" wire basket (1 per carton) |
| #63020-2 | 6" wire basket (2 per carton) |



### Mobile Equipment Cart

- Powder coated steel cabinet with black, locking casters
- Rubber bumpers to prevent wall damage
- Contoured top covered in a bacteriological chemical, and fungal resistant material
- Two handles integrated directly into the cart
- Cart size: 34.4"H x 24.2"W x 21.6"D (87.4 cm x 61.5 cm x 54.9 cm)
- 3 small drawers: 4.0"H x 19.7"W x 19.2"D (10.2 cm x 50 cm x 48.8 cm)
- 1 large drawer: 10.0"H x 19.7"W x 19.2"D (25.4 cm x 50 cm x 48.8 cm)

#63100

accessories

- |         |                 |
|---------|-----------------|
| #100407 | drawer dividers |
|---------|-----------------|

# SUPPORT PRODUCTS



## Mobile Instrument Stand

- Adjustable height for comfortable use while sitting or standing
- 1" (2.5 cm) chrome plated steel tubing
- Stable five-leg cast aluminum base
- Removable stainless steel tray:  
19.2" x 12.7" x 0.75"  
(48.8 cm x 32.3 cm x 1.9 cm)
- 2" (5.1 cm) Dual wheel nylon casters
- Height: 29"-47.5" (73.6 cm x 120.7 cm)

#43465

accessories

#2102568 replacement tray



## Mayo Instrument Stand

- "California" style base for easy positioning
- 1" (2.54cm) chrome plated steel tubing
- Two rubber wheel, ball bearing casters
- Removable stainless steel tray:  
19.2" x 12.7" x 0.75"  
(48.8 cm x 32.3 cm x 1.9 cm)
- Base: 20" (50.8 cm) wheels, 19" (48.3 cm) dia.
- Height: 34" - 52" (86.4 cm x 132.1 cm)

#11100

accessories

#2102568 replacement tray



## Mayo Instrument Stand

- Designed for convenience during surgeries
- 1" (2.54cm) chrome plated steel tubing
- U-shaped base minimizes interference
- Two rubber wheel, ball bearing casters
- Removable stainless steel tray:  
19.2" x 12.7" x 0.75"  
(48.8 cm x 32.3 cm x 1.9 cm)
- Base: 19"(48.3 cm) wheels, 21"(53.3 cm) dia.
- Height: 31" - 48.5" (78.7 cm - 123.2 cm)

#43460

accessories

#2102568 replacement tray



## Stainless Steel Mayo Stand

- Non-corrosive stainless steel construction
- Removable stainless steel tray:  
19.2" x 12.7" x 0.75"  
(48.8 cm x 32.3 cm x 1.9 cm)
- Height: 31" - 48.5" (78.7 cm - 123.2 cm)
- Rubber wheel, ball bearing casters

#48461

accessories

#2102568 replacement tray



## Kick Bucket w/Frame

- Non-corrosive stainless steel construction
- Heavy duty, exceptionally durable
- 360° rubber bumper on frame
- 13 quart size (3.25 gal)
- 2" (5.1 cm) rubber casters

#48711

#48712 kick bucket only

#48714 kick bucket frame only



## "H" Base Table

- Easy spring loaded height adjustment
- Four point H-base with two locking dual wheel nylon casters
- Height: 26.75"-43.25" (68 cm-109.9 cm)
- Base: 15.25" x 26.38" (38.7 cm - 67 cm)
- Top: 15" x 30" (38.1 cm - 76.2 cm)
- Weight capacity: 50 lb (22 kg)
- Some assembly required

#11600 "H" base  
gray laminate top, gray epoxy finish on base  
#11610 "H" base  
walnut grain laminate top, chrome base



## "U" Base Tables

- "U" base to fit easily in restricted space
- Easy spring loaded height adjustment
- Four point U-base with two locking dual wheel nylon casters
- Height: 26.75"-43.25" (68 cm-109.9 cm)
- Base: 15.25" x 26.38" (38.7 cm - 67 cm)
- Top: 15" x 30" (38.1 cm - 76.2 cm)
- Weight capacity: 50 lb (22 kg)
- Some assembly required

#11620 "U" base  
walnut grain laminate top, chrome base

#11630 "U" base  
gray laminate top, gray epoxy finish on base



## Low "H" Base Table

- Convenient table solution for low care beds
- Easy spring loaded height adjustment
- H-base with two locking dual wheel casters
- 1.75" (4.5 cm) casters and plastic glides incl.
- Height:  
Casters 19.375" - 26.5" (49.2 cm - 67.3 cm);  
Glides 17.625" - 24.5" (44.8 cm - 62.2 cm)
- Base: 15.25" x 26.38" (38.7 cm x 67 cm);
- Top: 15" x 30" (38.1 cm x 78.7 cm)
- Ground clearance: .5" (1.3 cm) with glides;  
2.25" (5.7 cm) with casters
- Weight capacity: 50 lb (22 kg)
- Some assembly required

#11640 low "H" base  
walnut grain laminate top, chrome base





### Step Stool with Hand Rail

- Chrome plated 18 gauge steel for durability
- Skid resistant rubber mat for safety
- Dimensions: 8.75" H x 11.25" W x 14.25" L (22.2 cm x 28.6 cm x 36.2 cm)
- Handrail is .88" (2.2 cm) chrome plated steel
- Height: 35.75" (90.8 cm), top of rail to floor
- Weight capacity: 350 lb (158 kg)
- Some assembly required

#11220

accessories

#99121 replacement crutch tips (set of 4)



### Step Stool

- Chrome plated 18 gauge steel for durability
- Skid resistant rubber mat for safety
- Dimensions: 8.75" H x 11.25" W x 14.25" L (22.2 cm x 28.6 cm x 36.2 cm)
- Weight capacity: 350 lb (158 kg)

#11200-1 1 stool per box  
#11200-2 2 stools per box

accessories

#99121 replacement crutch tips (set of 4)



### Bariatric Step Stool with Hand Rail

- Chrome plated 16 gauge steel for durability
- Skid resistant rubber mat for safety
- Dimensions: 8.75" H x 11.25" W x 14.25" L (22.2 cm x 28.6 cm x 36.2 cm)
- Handrail is 1" (2.5 cm) chrome plated steel
- Height: 34.5" (87.6 cm), top of rail to floor
- Weight capacity: 600 lb (272 kg)
- Some assembly required

#21200 step stool

#21220 step stool w/hand rail

accessories

#99121 replacement crutch tips (set of 4)



### Two-Step, Step Stool with Hand Rail

- Chrome plated 16 gauge steel for durability
- Skid resistant rubber mat for safety
- Dimensions (first step): 9" H x 12" W x 16" L (22.9 cm x 30.5 cm x 40.6 cm)
- Dimensions (second step): 7" H x 12" W x 16" L (17.8 cm x 30.5 cm x 40.6 cm)
- Handrail is 1" (2.5 cm) chrome plated steel; can be mounted to either side of step
- Height: 43" (109.2 cm) from top at highest point of rail to floor
- Weight capacity: 600 lb (272 kg)
- Some assembly required

#31200 step stool

#31220 step stool w/hand rail

accessories

#50016-1 hand rail



11.5"D x 12.25"W x 18.25"H  
(29.2 cm x 31.1 cm x 46.4 cm)  
32 quart capacity (8 gallon)

#### Large Square Steel Waste Can

#35266 White enamel finish, 32 qt.  
#35267 Red enamel finish, 32 qt.  
#35268 Beige enamel finish, 32 qt.



11" D x 11.75" W x 17.25" H  
(27.9 cm x 29.9 cm x 43.8 cm)  
20 quart capacity (5 gallon)

#### Small Square Steel Waste Can

#35269 White enamel finish, 20 qt.  
#35270 Red enamel finish, 20 qt.  
#35271 Beige enamel finish, 20 qt.



11.5" D x 24" H  
(29.2 cm x 61 cm)  
32 quart capacity (8 gallon)

#### Large Round Steel Waste Can

#45266 White enamel finish, 32 qt.  
#45267 Red enamel finish, 32 qt.  
#45268 Beige enamel finish, 32 qt.  
#45269 Stainless Steel finish, 32 qt.



12" D x 15" W x 26" H  
(30.5 cm x 38.1 cm x 66 cm)  
52 quart capacity (13 gallon)

#### Large Rectangular Plastic Waste Can

#25266 White plastic, 52 qt.  
#25267 Red plastic, 52 qt.  
#25268 Beige plastic, 52 qt.



12" D x 15" W x 19" H  
(30.5 cm x 38.1 cm x 48.3 cm)  
32 quart capacity (8 gallon)

#### Small Rectangular Plastic Waste Can

#25269 White plastic, 32 qt.  
#25270 Red plastic, 32 qt.  
#25271 Beige plastic, 32 qt.



Biohazard waste label included with every waste can. Shipped inside the waste can.

## Standard Upholstery Color Selections

*For Brewer Tables, Side Chairs, Blood Drawing Chairs and Exam Stools*



Clamshell (21) PR 57



Gunmetal (22) PR 92  
Vacuum Upholstery DAV 016



Feather (23) PR 37



Black Satin (24) PR 40



Saddle (25) PR 52



Tapestry Red (26) PR 47



Cabernet (27) PR 36

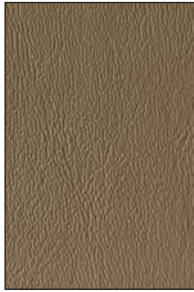

Cocoa (28) PR 51

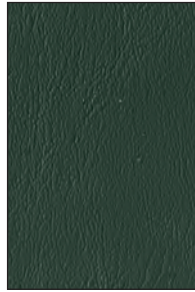

Deep Sea (29) PR 49

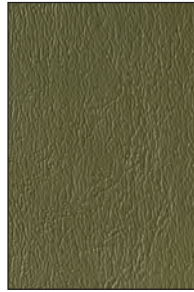

Ivy (30) PR 53



Deep Sapphire (31) PR 55



Blue Fog (32) PR 46

## California Technical Bulletin 133 Upholstery Color Selections (CAL-133)

*For Brewer Tables, Century Series Stools and Value Plus Series Pneumatic Stools*



Clamshell PH 57



Almond PH 59



Slate Blue PH 50



Nearly Black PH 64

**CAL TB 133** is a written legal standard outlining flammability test procedures for upholstered furniture. These vinyl color selections contain a flame blocking barrier that helps to prevent ignition, reflects heat and is flame retardant.

## Premium Plush Upholstery Color Selections

*For Brewer Assist Procedure Tables, Access High-Low Exam Tables, Side Chairs and Century Series Stools*



Beech ULU 5638

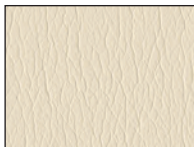

Arctic (50) UL 5684



Charcoal (51) UL 5763

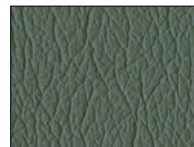

Shetland (52) UL 4351

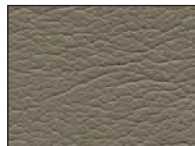

Stone (53) UL 3602



Admiral (55) UL 2556

All Premium Plush Upholstery Colors are Ultrafabrics ULTRALEATHER™.

**Note:** Tables featuring a plush upholstery top are two-toned, stitched, with Stucco and one of the premium plush upholstery colors. Exam stools and side chairs are one solid color, stitched. (-UL)

**For Actual Material Swatches call 1 • 888 • Brewer • 1**

# Additional Standard Upholstery Color Selections

## For Brewer Exam Stools Only



Alabaster US 396  
Vacuum Upholstery AVS9051



Strato Grey AMB 110



Cloud Grey DUR 006



Dove US 413  
Vacuum Upholstery AVS9053



Ash DUR 002  
Vacuum Upholstery DAV 011



Greystone US 425



Gunmetal US 392  
Vacuum Upholstery DAV 016

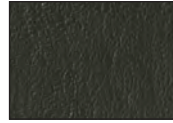

Graphite SF 73



Black HAM 114



Clamshell PR 57

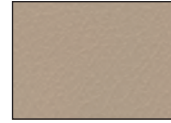

Mushroom LV 017



Putty US 403

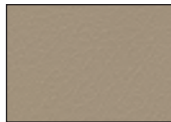

Taupe DUR 009  
Vacuum Upholstery DAV 006



Grey Taupe TL 58

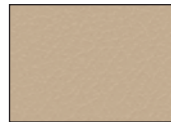

Bone DUR 012



Sand US 384



Buckskin RU 840

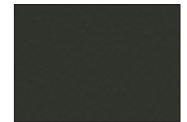

Chocolate HAM 122

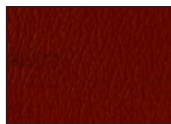

Claret US 357  
Vacuum Upholstery AVS2083

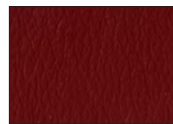

Port NEO 62



Spanish Tile HAM 106



Desert Rose DUR 003  
Vacuum Upholstery DAV 007

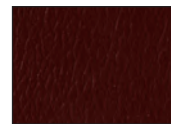

Burgundy US 364



Petal SF 88



Mauve AM 45

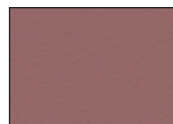

Mauve DUR 018

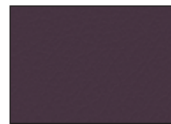

Purple Grey DUR 007  
Vacuum Upholstery DAV 009

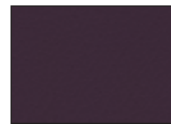

Black Plum CG 3767

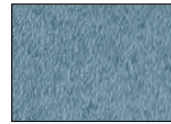

Tradewind TL 60



Atlantis DUR 031



Blue Fog PR 46

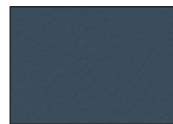

Agate Blue LV 003

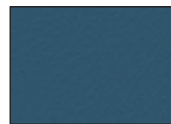

Azure Blue SR 106

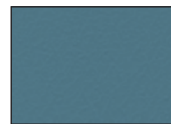

Wedgewood DUR 001  
Vacuum Upholstery DAV 002

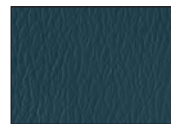

Slate Blue NEO 26  
Vacuum Upholstery AVS1446



Wedgewood MS 68



Cobalt DUR 005  
Vacuum Upholstery DAV 001



Royal US 354  
Vacuum Upholstery AVS9050



Adriatic DUR 026

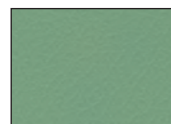

Seafoam CG 3550



Dusty Jade DUR 010  
Vacuum Upholstery DAV 003



Teal LV 001



Sage HAM 105  
Vacuum Upholstery DAV 004



Grey Teal DUR 017



Emerald NEO 40



Forest Green HAM 124



Black US 393  
Vacuum Upholstery DAV 013

# Brewer

*The Power to Advance*

The Brewer Company, LLC  
N88W13901 Main Street, Suite 100  
Menomonee Falls, WI 53051

**P** 1.888.Brewer.1

**F** 262.251.2332

[www.brewercompany.com](http://www.brewercompany.com)

